

高频共模扼流滤波器

DC Common Mode (Filter-High Frequency)

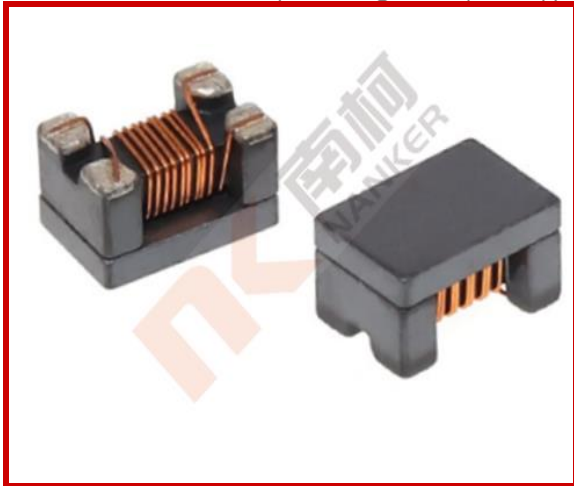

特性

Characteristics

电流补偿数据线滤波器

Current compensated data line filter

高频下的高共模噪声抑制

High common mode noise suppression at high frequencies

绕组对称性对高速信号影响小

Small influence on high speed signals through winding symmetry

应用

Application

USB 3.0, USB2.0

USB 3.0, USB2.0

HDMI

HDMI

产品品名介绍

Product Number Structure

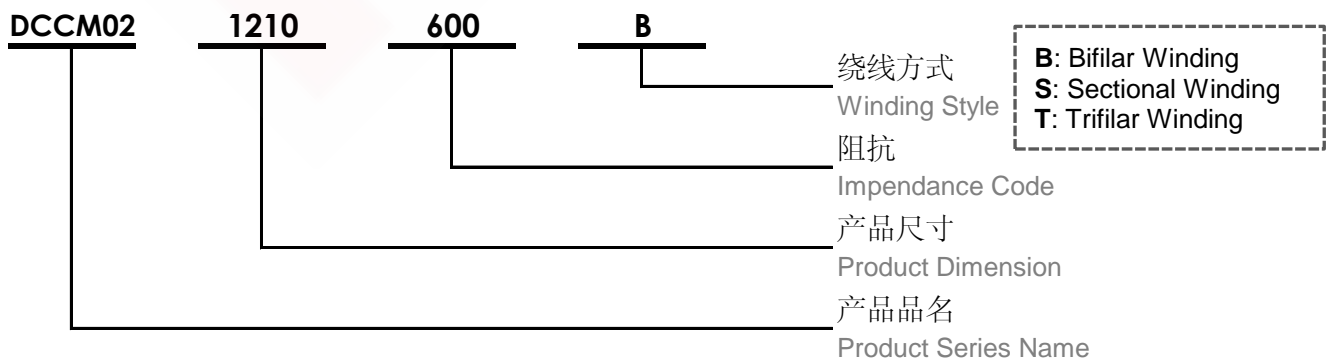



尺寸

Dimension (mm)

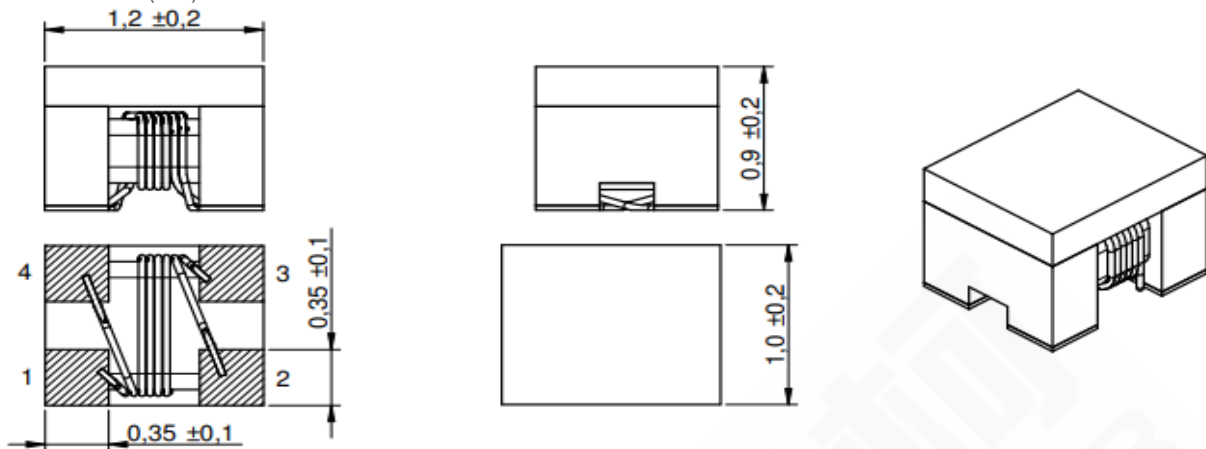

焊盘推荐

Land Pattern Recommended (mm)

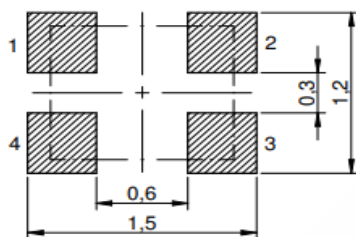

示意图

Schematics



电性特性

Electrical Properties

型号 Part No.	阻抗 Impedance Z (Ω)		温升电流 Rated Current I _r max 20°C (mA)	直流电阻 DC Resistance DCR _{max} (mΩ)	额定电压 Rated Voltage V _R	包装数量 Packaging Qty pcs
	10MHz	100MHz				
DCCM02-1210-600B	-	60 ±25%	600	220	20.00	3,000
DCCM02-1210-900B	-	90 ±25%	500	270	20.00	3,000

测试状态

Test Condition

- ☆ 阻抗测试条件为 100MHz (25°C)
Impedance measure condition at 100MHz (25°C)
- ☆ 工作温度: -40°C ~ +105°C
Operating Temperature: -40°C ~ +105°C



典型阻抗特性

Typical Impedance Characteristics

DCCM02-1210-600B

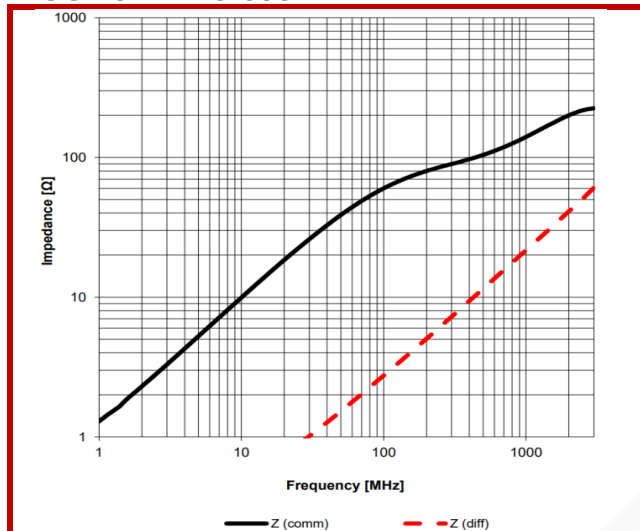

DCCM02-1210-900B

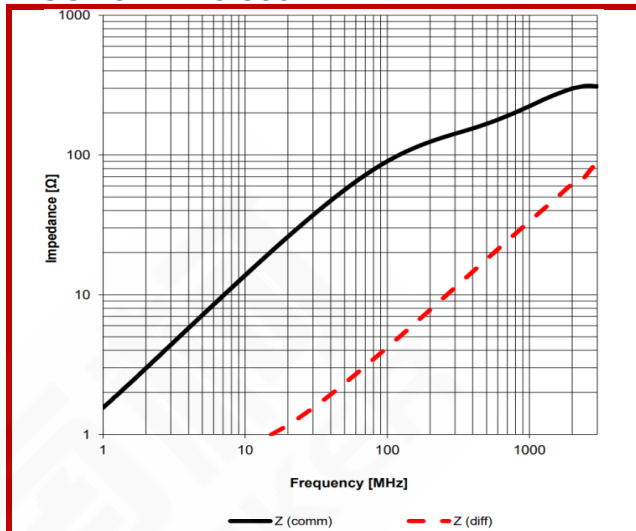



尺寸

Dimension (mm)

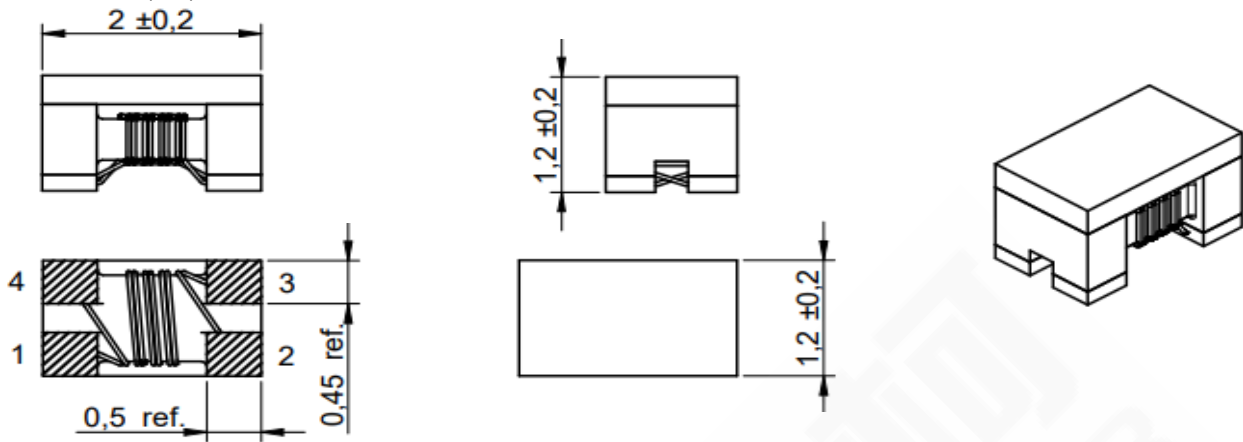

焊盘推荐

Land Pattern Recommended (mm)

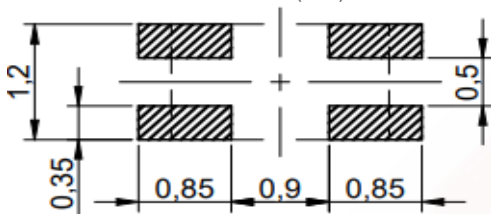

示意图

Schematics



电性特性

Electrical Properties

型号 Part No.	阻抗 Impedance Z (Ω)		温升电流 Rated Current I _r max 40°C (mA)	直流电阻 DC Resistance DCR _{max} (mΩ)	额定电压 Rated Voltage V _R	包装数量 Packaging Qty pcs
	10MHz	100MHz				
DCCM02-2012-670B	-	67 ±25%	320	240	50.00	2,000
DCCM02-2012-900B	-	90 ±25%	280	300	50.00	2,000
DCCM02-2012-121B	-	120 ±25%	280	300	50.00	2,000

测试状态

Test Condition

- ☆ 阻抗测试条件为 100MHz (25°C)
Impedance measure condition at 100MHz (25°C)
- ☆ 工作温度: -40°C ~ +105°C
Operating Temperature: -40°C ~ +105°C



典型阻抗特性

Typical Impedance Characteristics

DCCM02-2012-670B

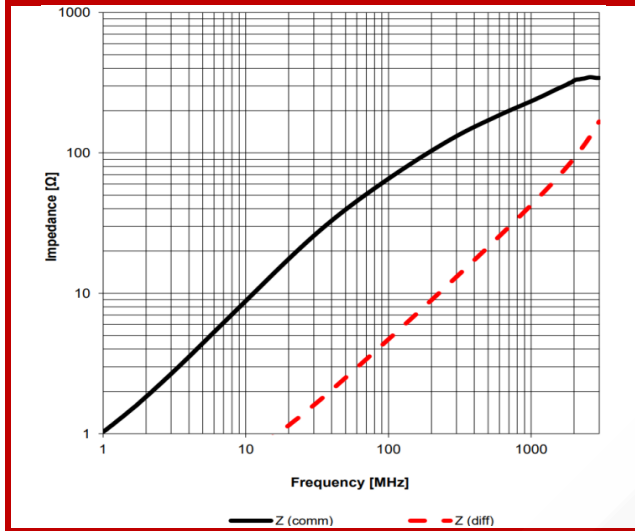

DCCM02-2012-900B

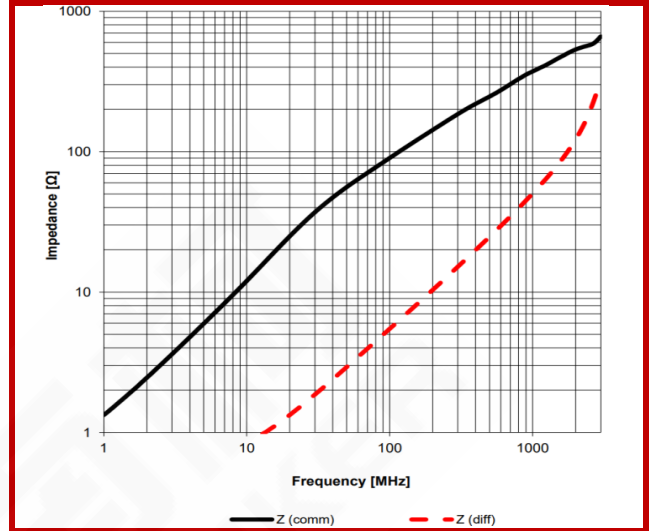

DCCM02-2012-121B

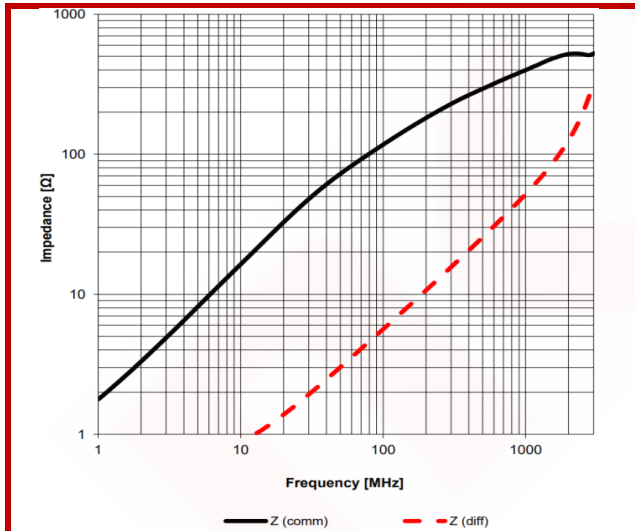



回流焊曲线图

Classification Reflow Profile for SMT Components

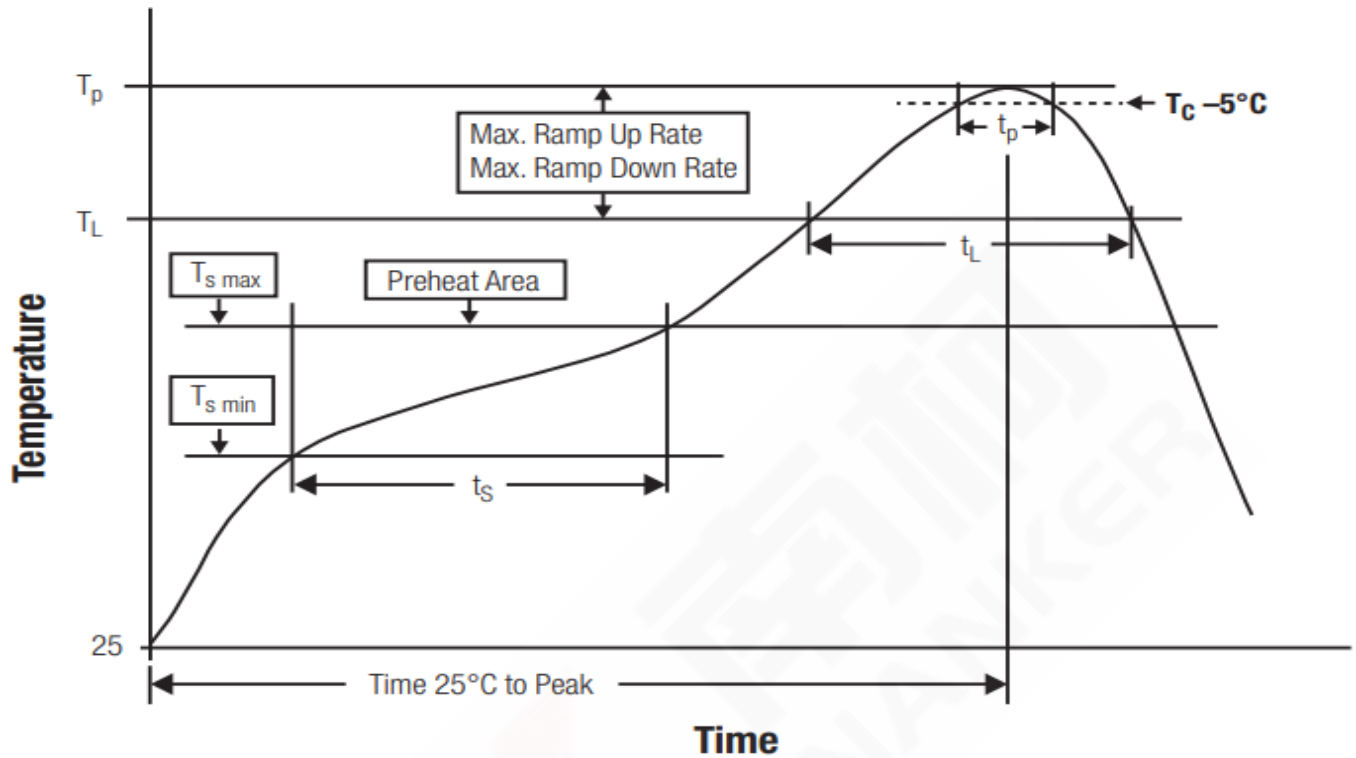

封装体峰值温度(T_p)分类

Classification Reflow Soldering Profile:

	封装厚度 Package Thickness	封装体积 Package Volume		
		<350 mm ³	350~2,000 mm ³	>2,000 mm ³
无铅装配 PB-Free Assembly	<1.60mm	260°C	260°C	260°C
	1.60~2.50mm	260°C	250°C	245°C
	>2.50mm	260°C	245°C	245°C

- ◆ 回流焊参照标准 IPC/JEDEC J-STD-020D。
Reflow is refer to standard IPC/JEDEC J-STD-020D.