

板对板连接器

Board To Board Connector

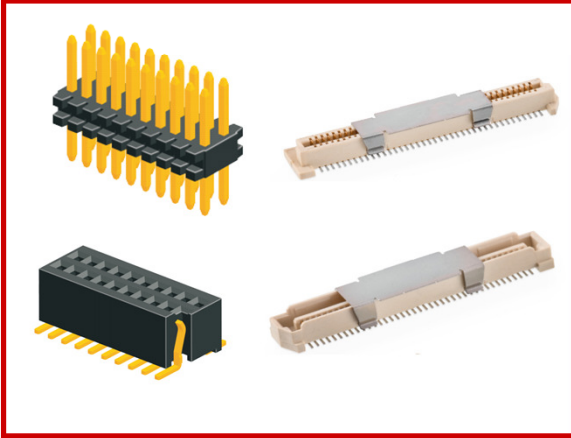

特性

Characteristics

提供不同的堆叠高度
offering different stacking heights

产品间距

Product Range

0.5,0.8,1.00,1.27,2.00,2.54

Order part number:

BTB 254 D D M 10 - V 0 0 0 xxx
 ① ② ③ ④ ⑤ ⑥ ⑦ ⑧ ⑨ ⑩ ⑪

- ① Type:BTB,PHD,FHD
- ② Pitch: 254-2.54mm pitch
- ③ Type: D-DIP,S-SMT
- ④ Number Of Row: D-Double /S-Single
- ⑤ Gender:F-Female/M-Male
- ⑥ Number Of Pin : 06- 6pins/10-10pins,100-100pins
- ⑦ Structure: V-Vertical,H-Horizontal
- ⑧ Material And Colour: 0-Standard
- ⑨ Packaging:0-Standard
- ⑩ Plated: 0-Standard
- (1)Series Number

PHD080DDMxx-V000101

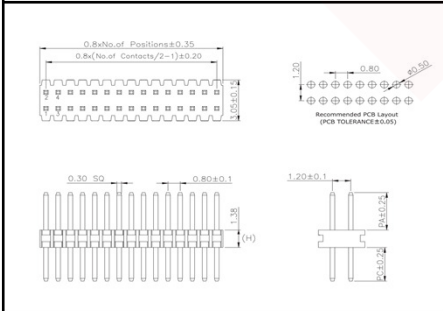
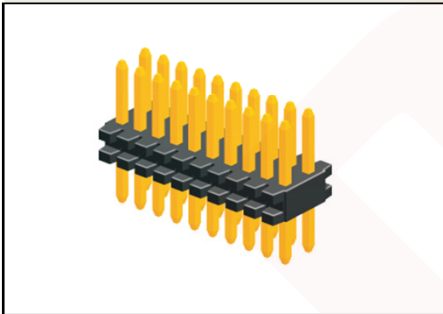

Technical Data

Current Rating: 0.75A
 Pitch: 0.8mm
 PA&PC&H Size: 2.8&2.2&1.38
 Solder type&Structure: DIP&Vertical
 Gender: Male

PHD080SDMxx-V000101

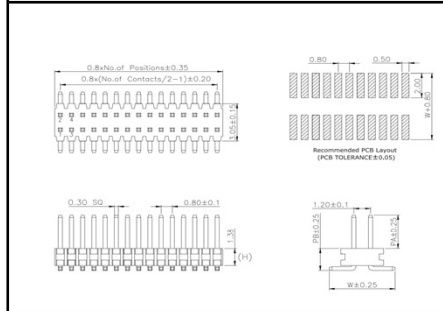
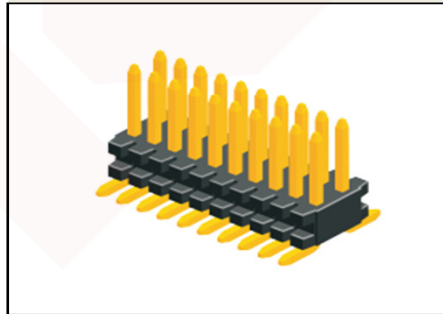

Technical Data

Current Rating: 0.75A
 Pitch: 0.8mm
 Current Rating: 2.8&1.8&1.38
 Solder type&Structure: SMT&Vertical
 Gender: Male

PHD100DSMxx-V000101

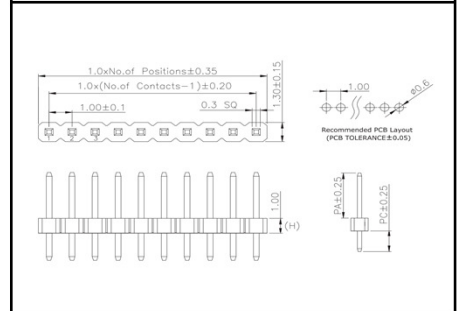
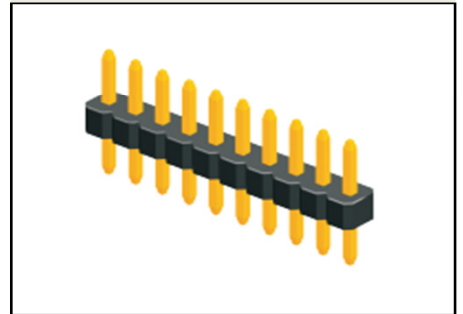

Technical Data

Current Rating: 0.75A
 Pitch: 1.0mm
 Current Rating: 2.0&1.7&1.0(1.5)
 Solder type&Structure: SMT&Vertical
 Gender: Male

PHD100DSMxx-V000102

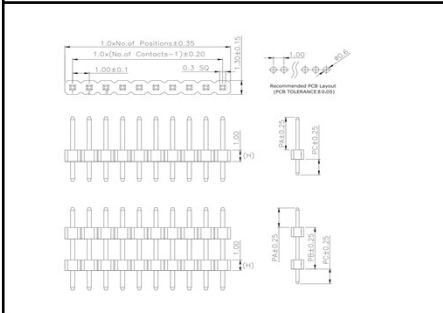
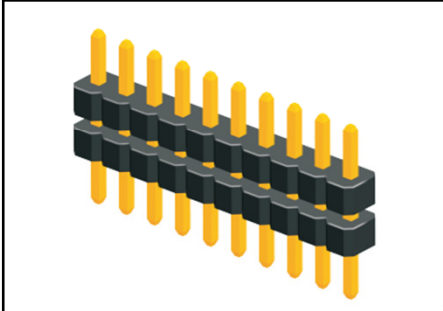

Technical Data

Current Rating:	0.75A
Pitch	1.0mm
PA&PB&H Size	1.9&2.5&1.0(1.5)
Solder type&Structure	DIP&Vertical
Gender	Male

PHD100DDMxx-V000101

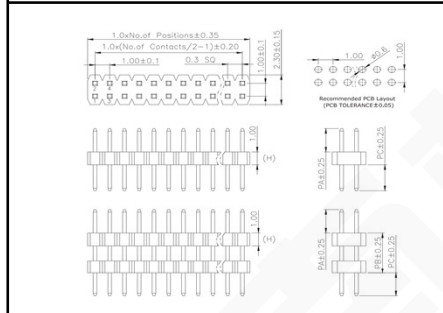
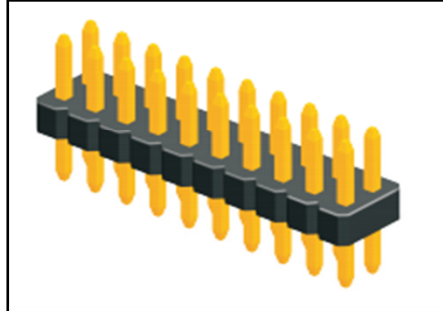

Technical Data

Current Rating:	0.75A
Pitch	1.0mm
PA&PC&H Size	2.0&1.8&1.0(1.5&2.0)
Solder type&Structure	DIP&Vertical
Gender	Male

PHD100DDMxx-V000102

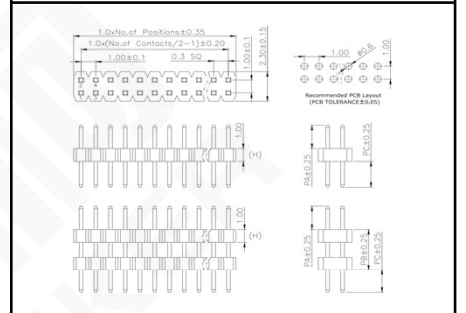
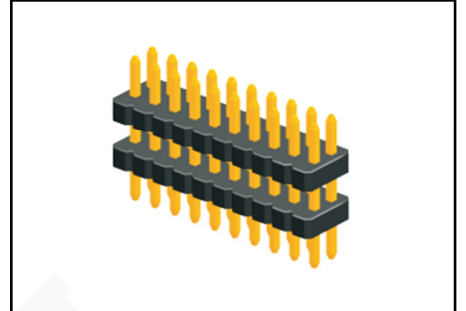

Technical Data

Current Rating:	0.75A
Pitch	1.0mm
PA&PD&H Size	2.0&3.4&1.0(1.5&2.0)
Solder type&Structure	DIP&Vertical
Gender	Male

PHD100DSMxx-H000101

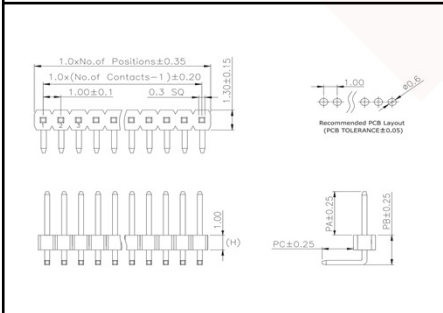
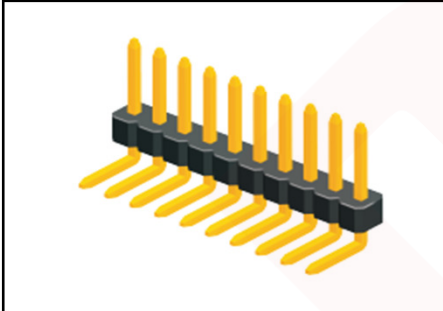

Technical Data

Current Rating:	0.75A
Pitch	1.0mm
PA&PC&H Size	3.0&2.0&1.0(1.5)
Solder type&Structure	DIP&Horizontal
Gender	Male

PHD100DDMxx-H000102

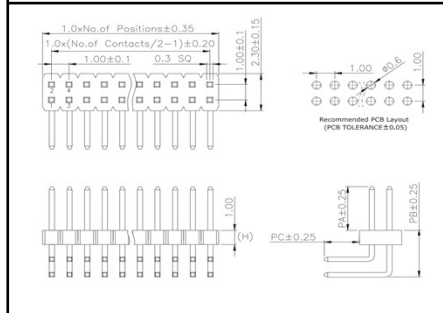
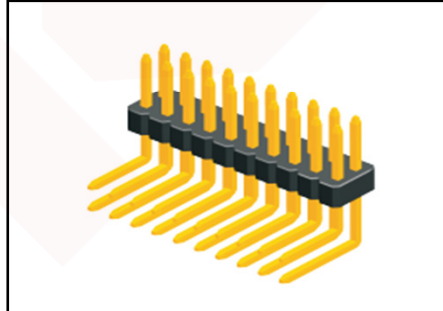

Technical Data

Current Rating:	0.75A
Pitch	1.0mm
PA&PC&H Size	2.5&3.54&1.0(1.5)
Solder type&Structure	DIP&Horizontal
Gender	Male

PHD100SSMxx-H000101

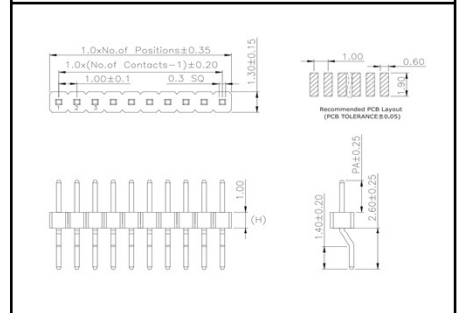

Technical Data

Current Rating:	0.75A
Pitch	1.0mm
PA&H Size	3.0&1.0(1.5)
Solder type&Structure	SMT&Horizontal
Gender	Male

PHD100SDMxx-V000102

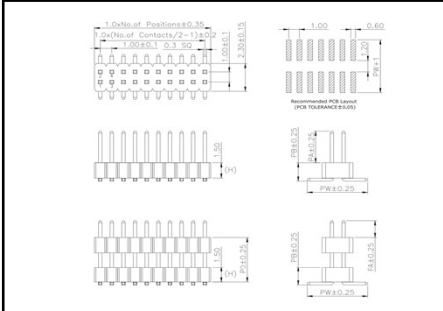
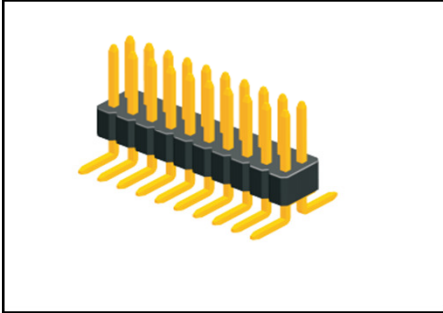

Technical Data
 Current Rating: 0.75A
 Pitch: 1.0mm
 PA&PC&H Size: 3.2&2.8&1.0(1.5&2.0)
 Solder type&Structure: DIP&Vertical
 Gender: Male

PHD100SDMxx-V000102

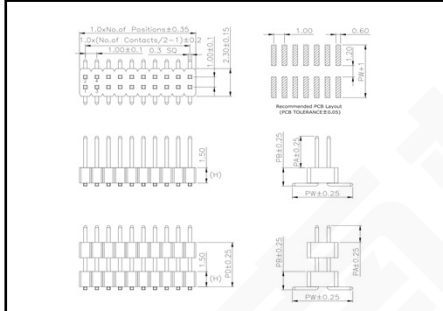
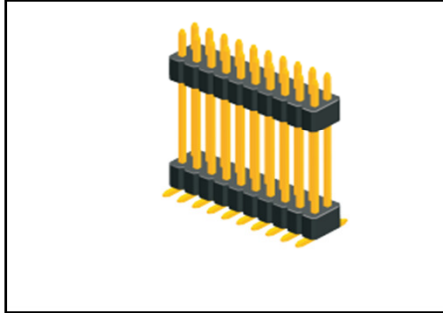

Technical Data
 Current Rating: 0.75A
 Pitch: 1.0mm
 PA&PD&H Size: 1.8&8.9&1.0(1.5&2.0)
 Solder type&Structure: DIP&Vertical
 Gender: Male

PHD127DSMxx-V000101

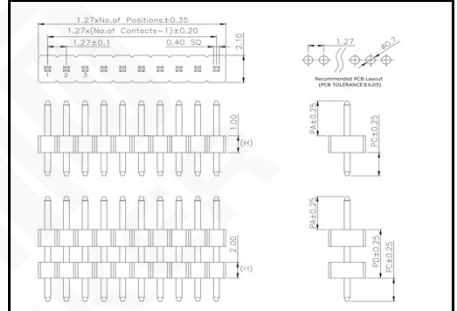
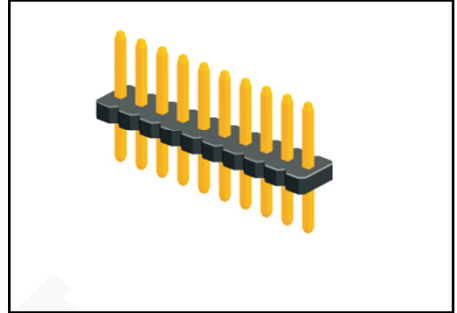

Technical Data
 Current Rating: 1A
 Pitch: 1.27mm
 PA&PC&H Size: 4.0&1.0&1.0(1.5&2.0&2.5)
 Solder type&Structure: DIP&Vertical
 Gender: Male

PHD127DSMxx-V000102

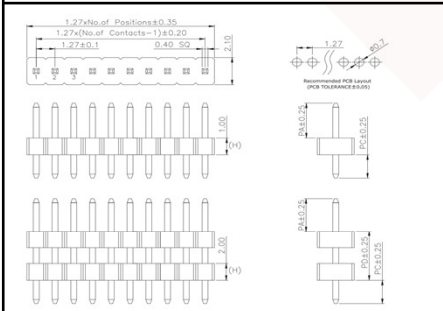
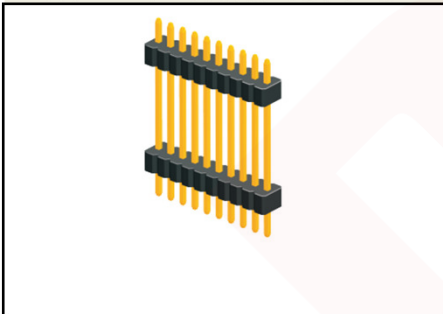

Technical Data
 Current Rating: 1A
 Pitch: 1.27mm
 PA&PD&H Size: 2.5&8.9&1.0(1.5&2.0&2.5)
 Solder type&Structure: DIP&Vertical
 Gender: Male

PHD127DDMxx-V000101

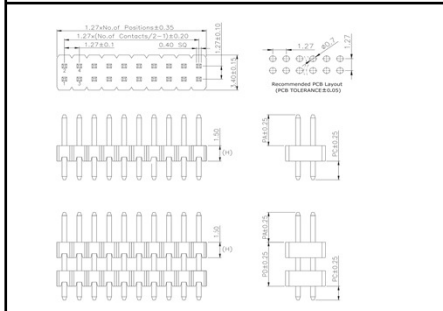
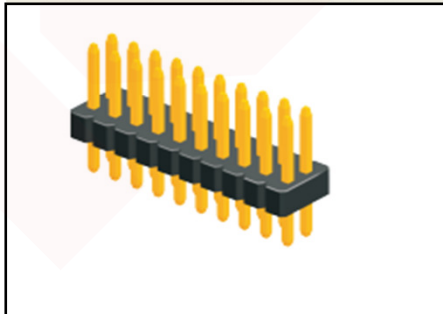

Technical Data
 Current Rating: 1A
 Pitch: 1.27mm
 PA&PC&H Size: 3.8&2.3&1.0(1.5&2.0&2.5)
 Solder type&Structure: DIP&Vertical
 Gender: Male

PHD127DDMxx-V000102

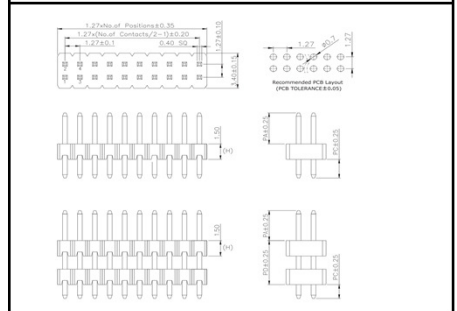
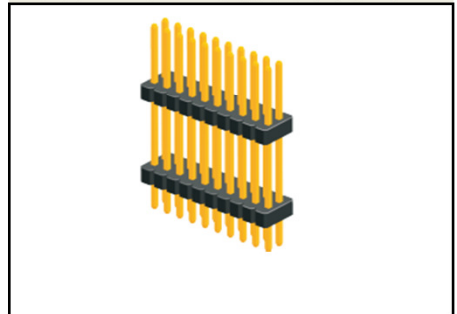

Technical Data
 Current Rating: 1A
 Pitch: 1.27mm
 PA&PD&H Size: 6&10&1.0(1.5&2.0&2.5)
 Solder type&Structure: DIP&Vertical
 Gender: Male

PHD200SSMxx-V000101

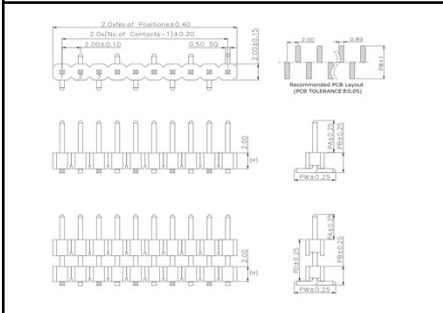
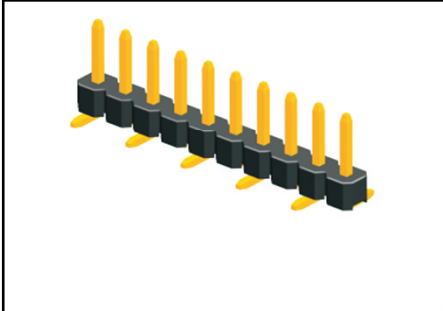

Technical Data
 Current Rating: 1.5A
 Pitch: 2.00mm
 PA&PC&H Size 4&3&2.0(1.0&1.5&3.0)
 Solder type&Structure SMT&Vertical
 Gender Male

PHD200SSMxx-V000102

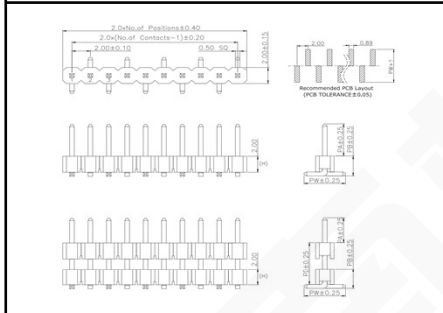
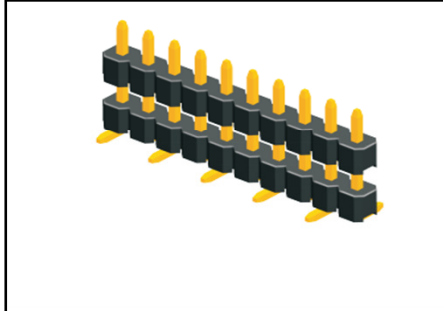

Technical Data
 Current Rating: 1.5A
 Pitch: 2.00mm
 PA&PD&H Size 4&3&2.0(1.0&1.5&3.0)
 Solder type&Structure DIP&Vertical
 Gender Male

PHD200SDMxx-V000101

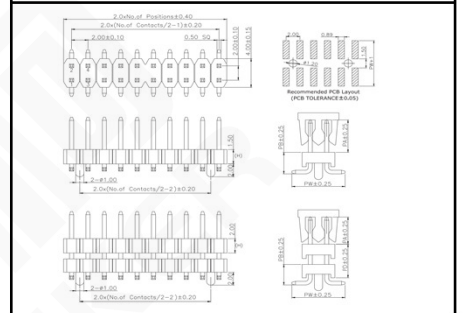
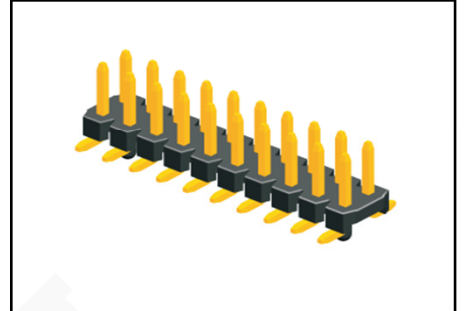

Technical Data
 Current Rating: 1.5A
 Pitch: 2.00mm
 PA&H Size 3.8&1.5(1.0&2.0)
 Solder type&Structure DIP&Horizontal
 Gender Male

PHD200SDMxx-V000102

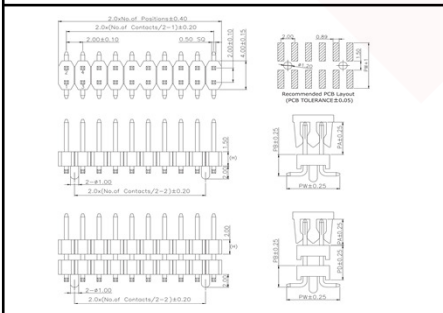
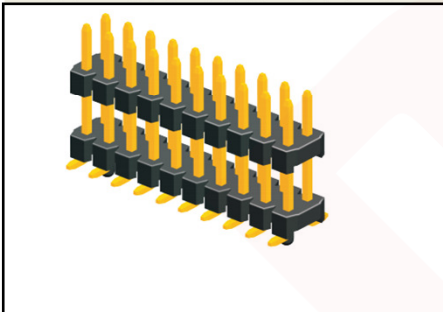

Technical Data
 Current Rating: 1A
 Pitch: 1.27mm
 PA&PD&H Size 4&7.86&2.0(1.0&1.5)
 Solder type&Structure DIP&Vertical
 Gender Male

PHD200SSMxx-H000101

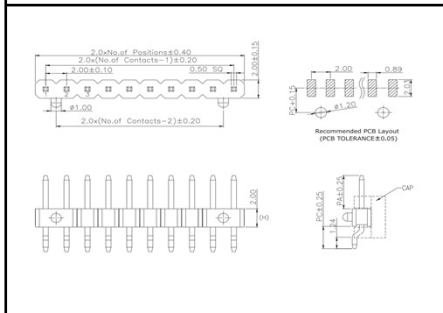
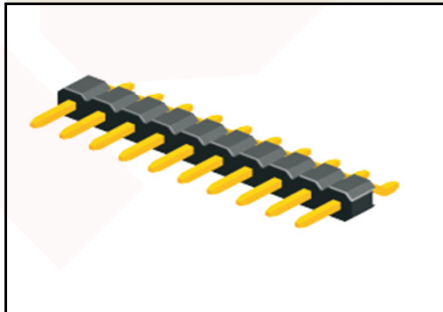

Technical Data
 Current Rating: 1.5A
 Pitch: 2.00mm
 PA&PC&H Size 4&3&2.0(1.0&1.5)
 Solder type&Structure DIP&Vertical
 Gender Male

PHD200SDMxx-H000101

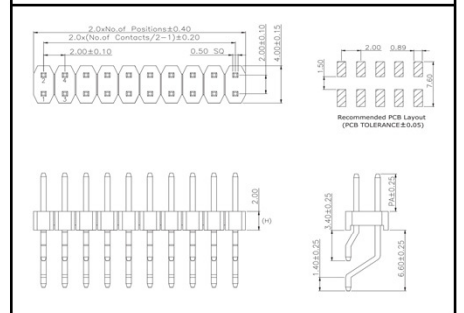
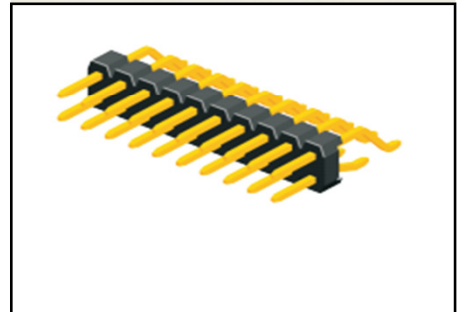

Technical Data
 Current Rating: 1.5A
 Pitch: 2.00mm
 PA&H Size 4&2.0(1.0&1.5)
 Solder type&Structure DIP&Vertical
 Gender Male

PHD254DSMxx-V000101

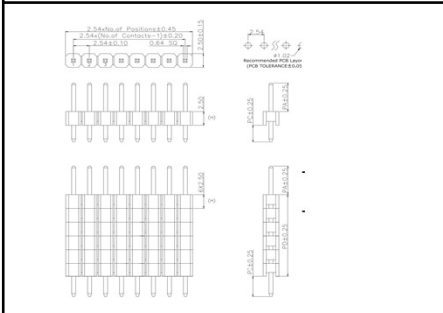
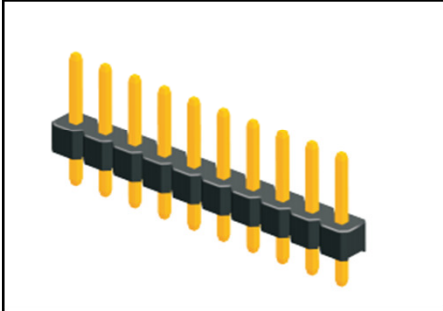

Technical Data
 Current Rating: 3A
 Pitch: 2.54mm
 PA&PC&H Size 6&3&2.0(1.0&1.5&2.5)
 Solder type&Structure DIP&Vertical
 Gender Male

PHD254DSMxx-V000102

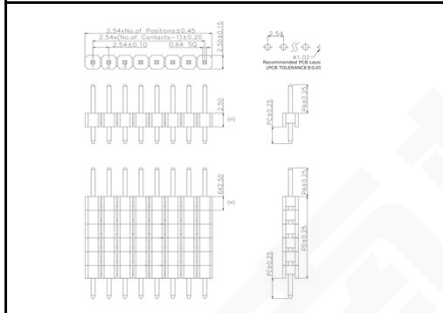
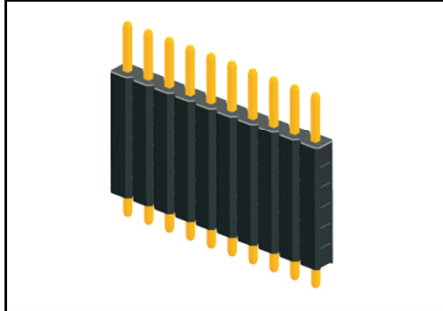

Technical Data
 Current Rating: 3A
 Pitch: 2.54mm
 PA&PC&H Size 6&3&2.5(1.0&1.5&2.0)
 Solder type&Structure DIP&Vertical
 Gender Male

PHD254DDMxx-V000101

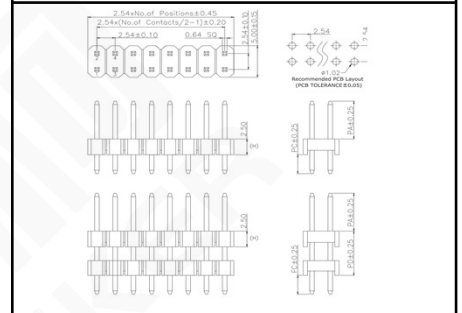
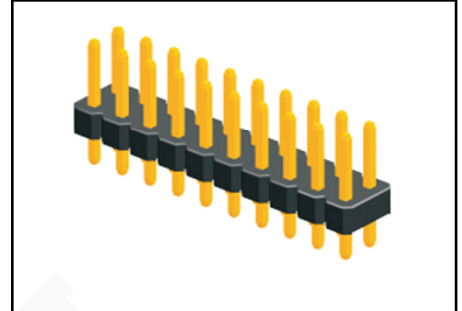

Technical Data
 Current Rating: 3A
 Pitch: 2.54mm
 PA&PC&H Size 6&3&2.0(1.0&1.5&2.5)
 Solder type&Structure DIP&Vertical
 Gender Male

PHD254DDMxx-V000102

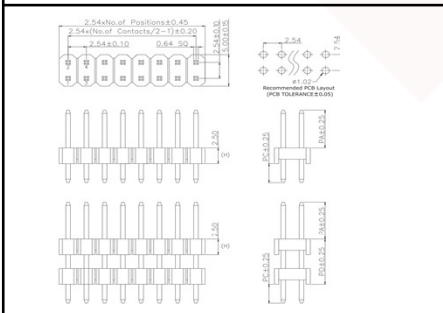
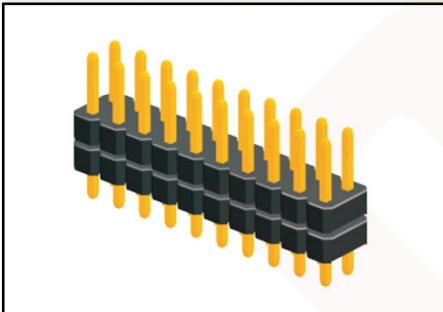

Technical Data
 Current Rating: 3A
 Pitch: 2.54mm
 PA&PD&H Size 6&5.5&2.5(1.0&1.5&2.0)
 Solder type&Structure DIP&Vertical
 Gender Male

PHD254DSMxx-H000101

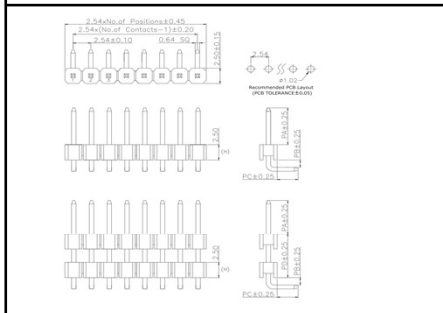
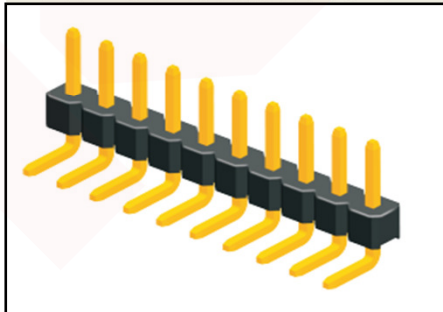

Technical Data
 Current Rating: 3A
 Pitch: 2.54mm
 PA&H Size 6&2.5(1.0&1.5&2.0)
 Solder type&Structure DIP&Horizontal
 Gender Male

PHD254DSMxx-H000102

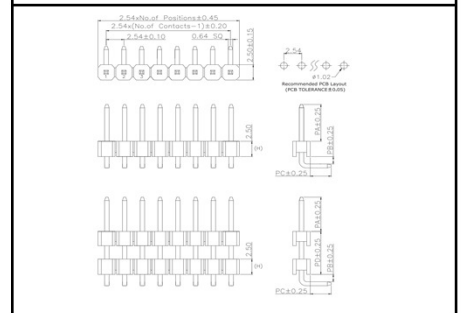
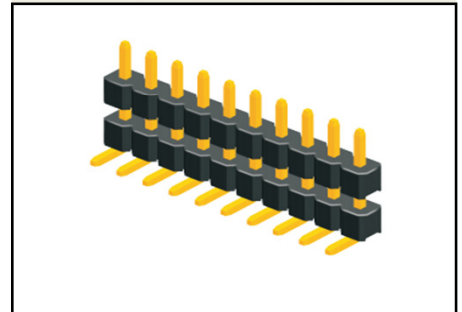

Technical Data
 Current Rating: 3A
 Pitch: 2.54mm
 PA&PD&H Size 3.5&6.64&2.5(1.0&1.5&2.0)
 Solder type&Structure DIP&Horizontal
 Gender Male

PHD254DDMxx-H000101

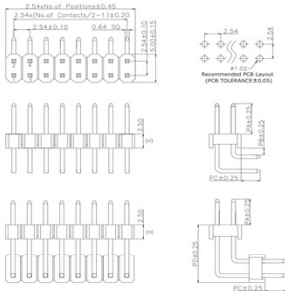
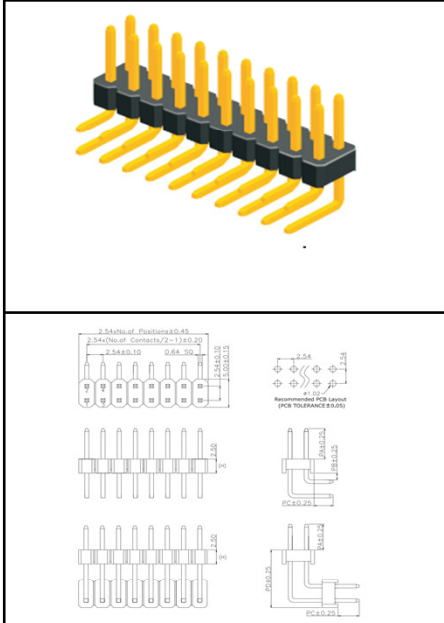

Technical Data

Current Rating: 3A
Pitch: 2.54mm
PA&PC&H Size: 6&3&2.0(1.0&1.5&2.5)
Solder type&Structure: DIP&Horizontal
Gender: Male

PHD254DDMxx-H000102

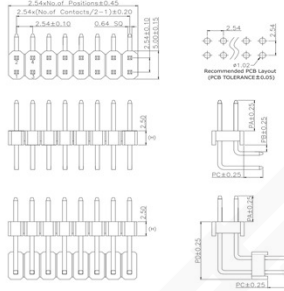
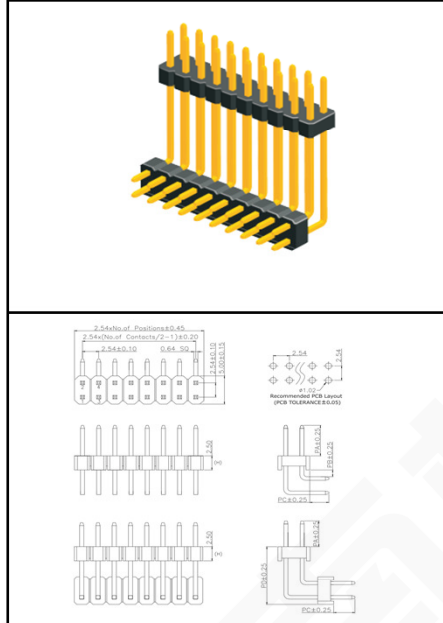

Technical Data

Current Rating: 3A
Pitch: 2.54mm
PA&PD&H Size: 5.8&19.63&2.5(1.0&2.0)
Solder type&Structure: DIP&Horizontal
Gender: Male

PHD254SSMxx-V000101

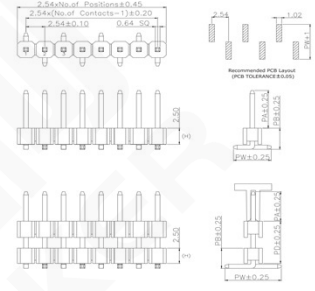
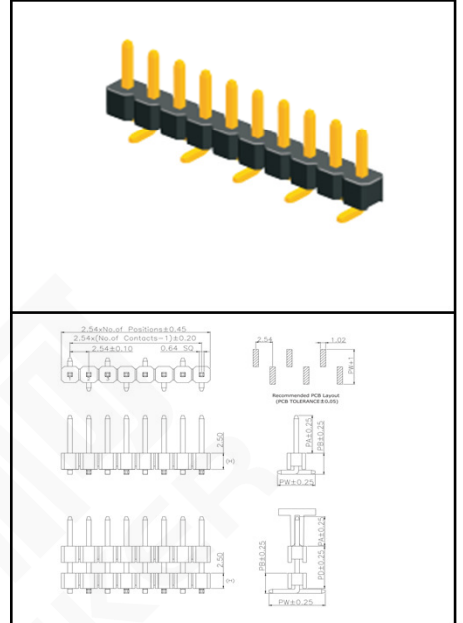

Technical Data

Current Rating: 3A
Pitch: 2.54mm
PA&PC&H Size: 4.5&3.5&2.5(1.0&1.5&2.0)
Solder type&Structure: SMT&Vertical
Gender: Male

PHD254SSMxx-V000102

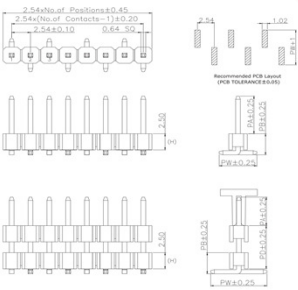
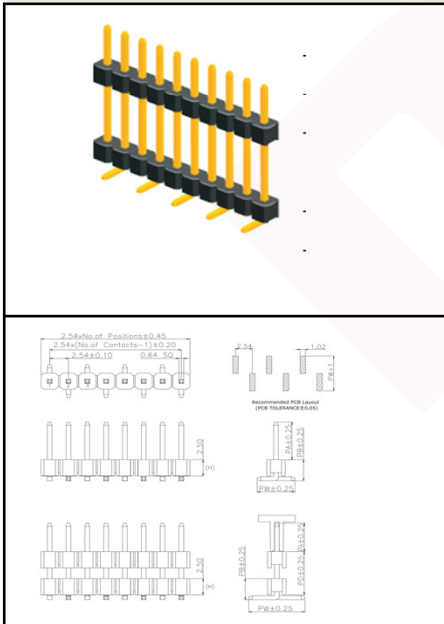

Technical Data

Current Rating: 3A
Pitch: 2.54mm
PA&PD&H Size: 5.7&13.92&2.5(1.0&2.0)
Solder type&Structure: SMT&Vertical
Gender: Male

PHD254SDMxx-V000101

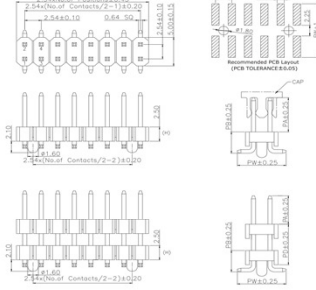
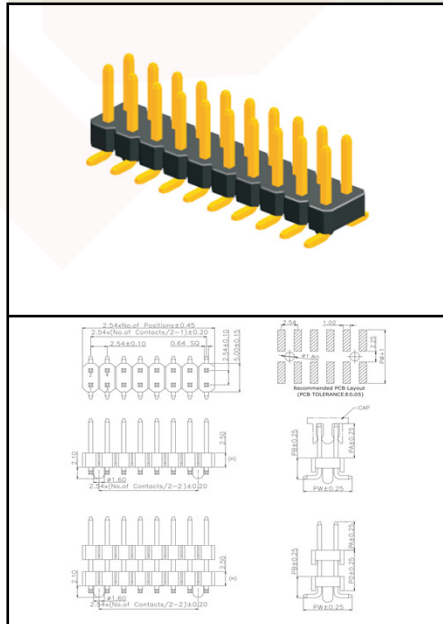

Technical Data

Current Rating: 3A
Pitch: 2.54mm
PA&PC&H Size: 6&3.75&2.5(1.0&1.5&2.0)
Solder type&Structure: SMT&Vertical
Gender: Male

PHD254SDMxx-V000102

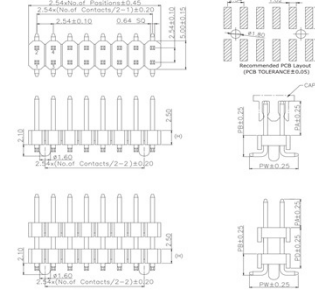
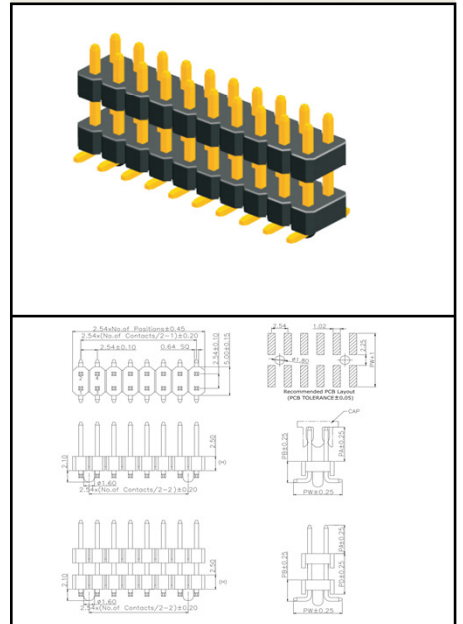

Technical Data

Current Rating: 3A
Pitch: 2.54mm
PA&PD&H Size: 3&8.2&2.5(1.0&2.0)
Solder type&Structure: SMT&Vertical
Gender: Male

PHD254SSMxx-H000101

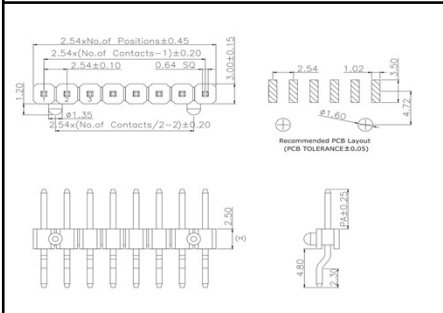
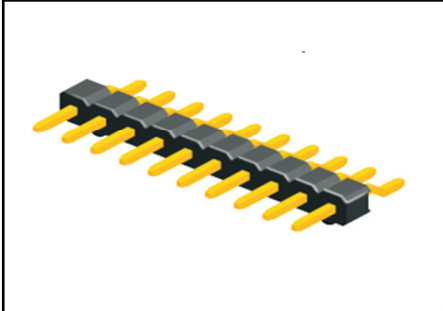

Technical Data

Current Rating:	3A
Pitch	2.54mm
PA&H Size	4&2.5(1.0&1.5&2.0)
Solder type&Structure	SMT&Horizontal
Gender	Male

PHD254SDMxx-H000101

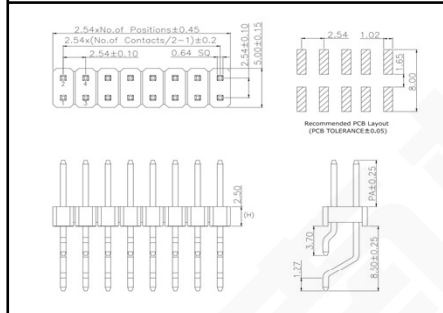

Technical Data

Current Rating:	3A
Pitch	2.54mm
PA&H Size	6&2.5(1.0&1.5&2.0)
Solder type&Structure	SMT&Horizontal
Gender	Male

PHD254DTMxx-V000101

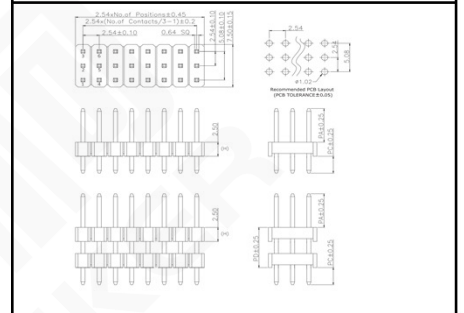
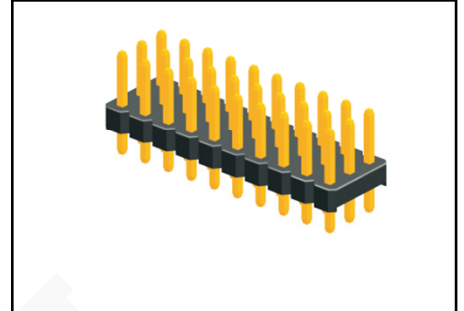

Technical Data

Current Rating:	3A
Pitch	2.54mm
PA&PC&H Size	6&3&2.5
Solder type&Structure	DIP&Vertical
Gender	Male

PHD254DTMxx-V000102

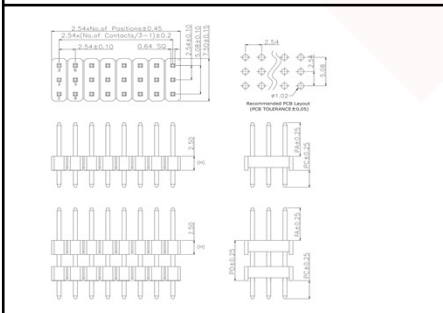
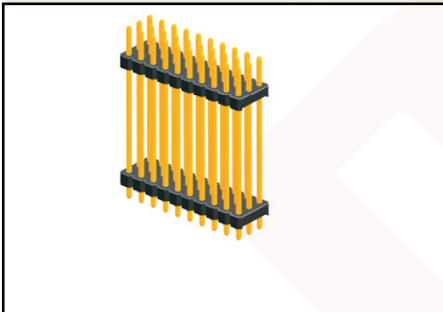

Technical Data

Current Rating:	3A
Pitch	2.54mm
PA&PD&H Size	6&27.5&2.5
Solder type&Structure	SMT&Vertical
Gender	Male

PHD254DTMxx-H000101

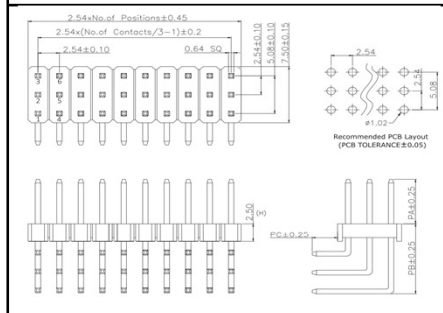
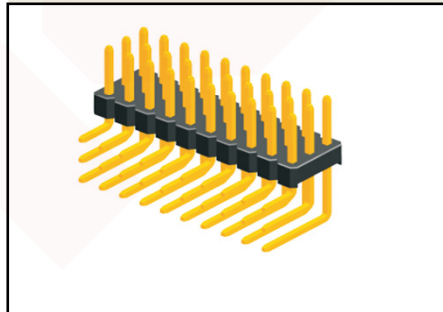

Technical Data

Current Rating:	3A
Pitch	2.54mm
PA&PC&H Size	6&3&2.5
Solder type&Structure	SMT&Vertical
Gender	Male

FHD080DDFxx-V000101

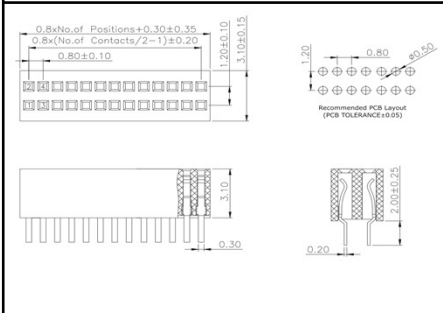
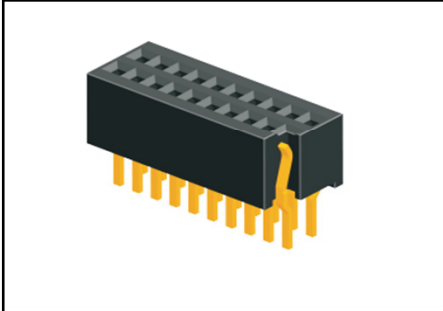

Technical Data

Current Rating:	0.75A
Pitch	0.8mm
H Size	3.1mm
Solder type&Structure	DIP&Vertical
Gender	Female

FHD080DDFxx-V000101

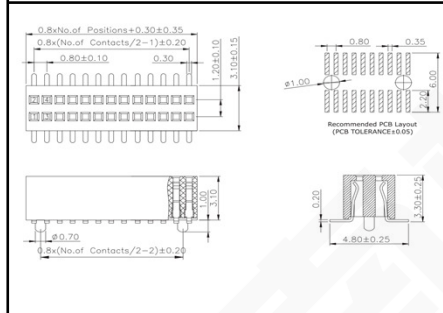
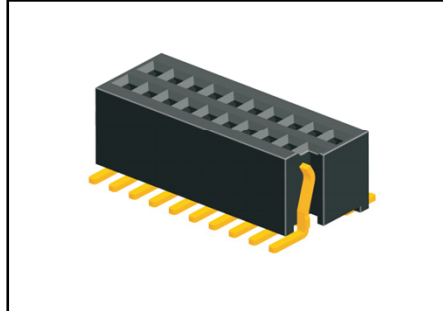

Technical Data

Current Rating:	0.75A
Pitch	0.8mm
PA&H Size	3.1mm
Solder type&Structure	SMT&Vertical
Gender	Female

FHD100DSFxx-V000101

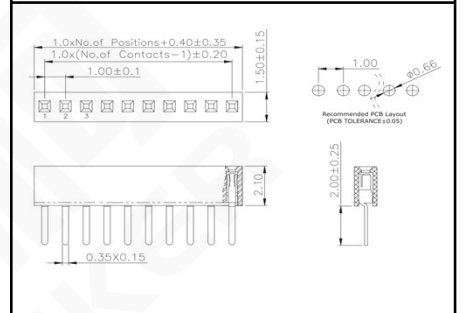
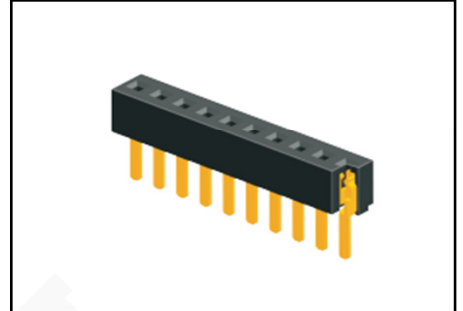

Technical Data

Current Rating:	0.75A
Pitch	1.0mm
PA&PC&H Size	2.1mm
Solder type&Structure	DIP&Vertical
Gender	Female

FHD100DDFxx-V000101

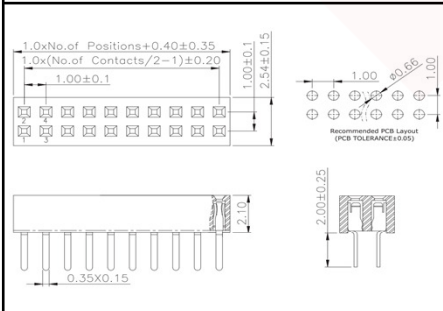

Technical Data

Current Rating:	0.75A
Pitch	1.0mm
H Size	2.1
Solder type&Structure	DIP&Vertical
Gender	Female

FHD100SSFxx-V000101

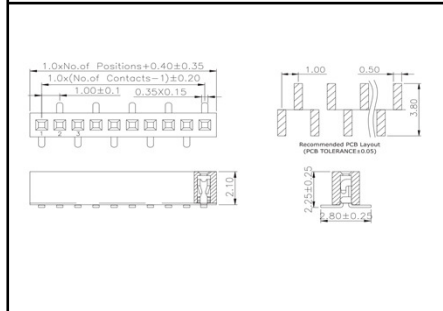
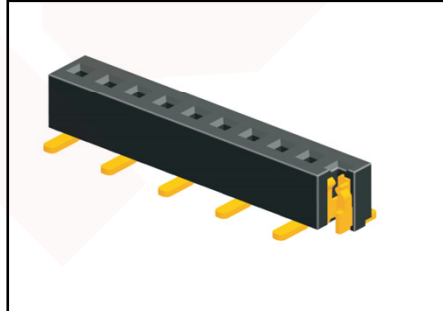

Technical Data

Current Rating:	0.75A
Pitch	1.0mm
H Size	2.1
Solder type&Structure	DIP&Vertical
Gender	Female

FHD100SSFxx-H000101

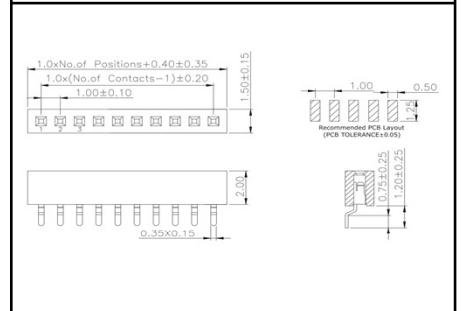

Technical Data

Current Rating:	0.75A
Pitch	1.0mm
H Size	2.1
Solder type&Structure	SMT&Horizontal
Gender	Female

FHD127DSFxx-H000101

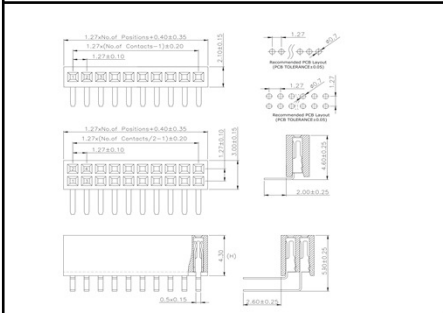
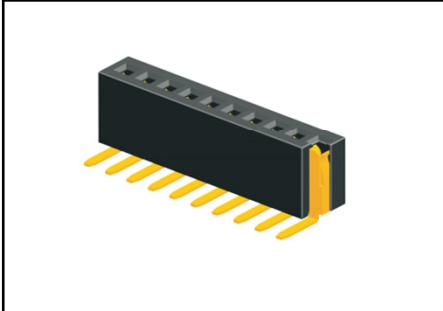

Technical Data

Current Rating:	1A
Pitch	1.27mm
H Size	4.3mm(3.4mm)
Solder type&Structure	DIP&Horizontal
Gender	Female

FHD127DDFxx-H000102

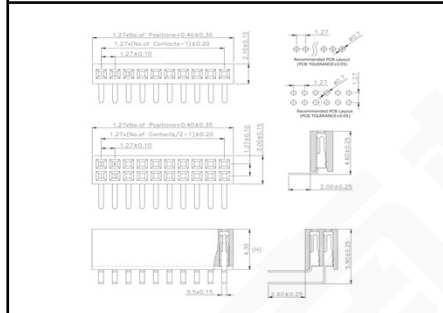
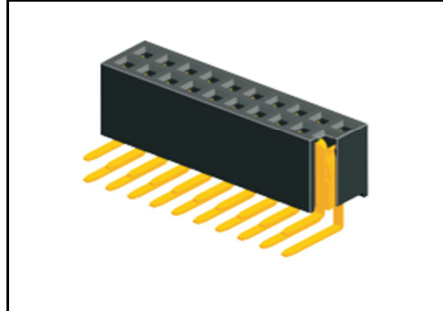

Technical Data

Current Rating:	1A
Pitch	1.27mm
H Size	4.3mm(3.4mm)
Solder type&Structure	DIP&Horizontal
Gender	Female

FHD127SSFxx-V000101

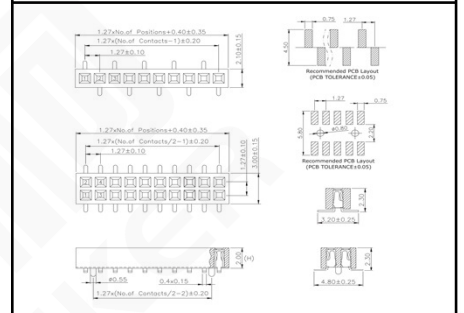

Technical Data

Current Rating:	1A
Pitch	1.27mm
H Size	2mm
Solder type&Structure	SMT&Vertical
Gender	Female

FHD127SDFxx-V000101

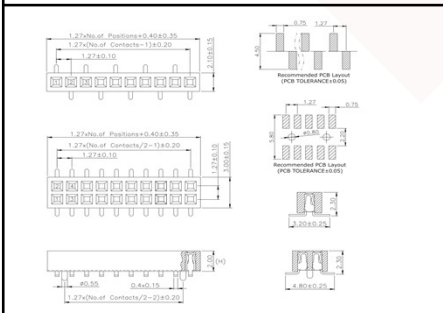
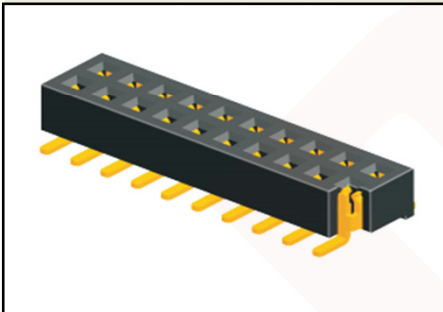

Technical Data

Current Rating:	1A
Pitch	1.27mm
H Size	2mm
Solder type&Structure	SMT&Vertical
Gender	Female

FHD127SSFxx-V000102

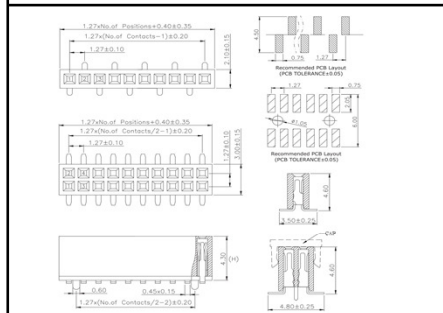
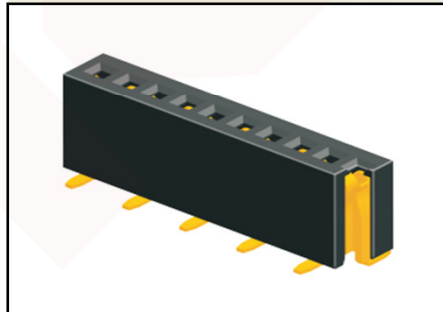

Technical Data

Current Rating:	1A
Pitch	1.27mm
H Size	4.3mm(3.4mm)
Solder type&Structure	SMT&Vertical
Gender	Female

FHD127SDFxx-V000102

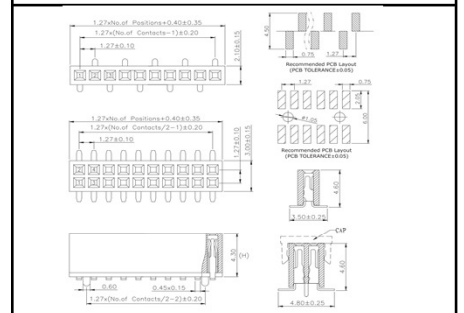
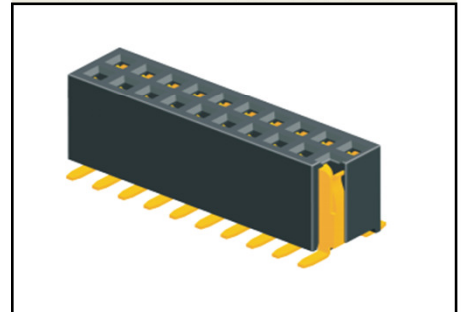

Technical Data

Current Rating:	1A
Pitch	1.27mm
H Size	4.3mm(3.4mm)
Solder type&Structure	SMT&Vertical
Gender	Female

FHD127SDFxx-V000104

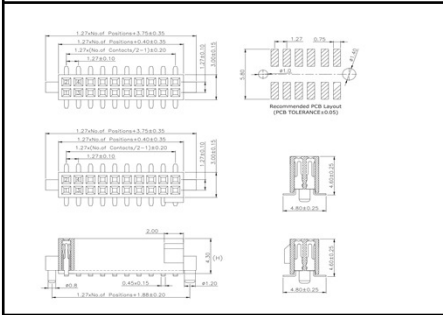
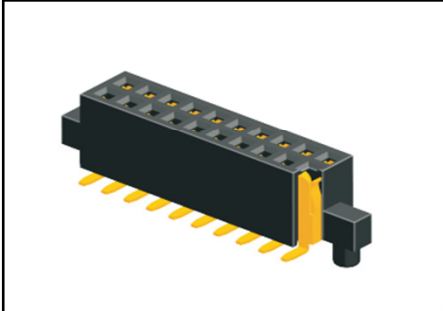

Technical Data	
Current Rating:	1A
Pitch	1.27mm
H Size	4.3mm
Solder type&Structure	SMT&Vertical
Gender	Female

FHD127SDFxx-V000105

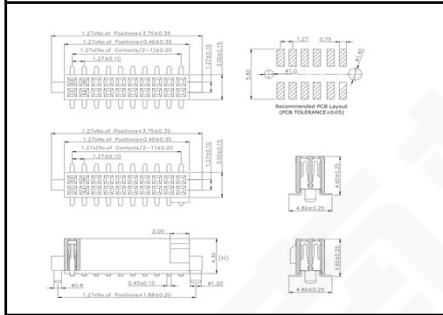
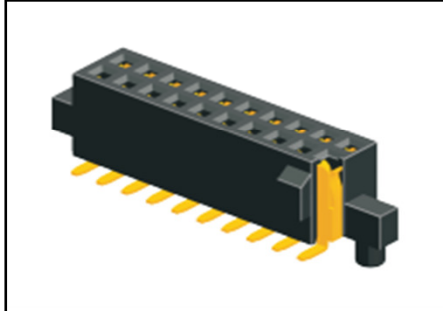

Technical Data	
Current Rating:	1A
Pitch	1.27mm
H Size	4.3mm
Solder type&Structure	SMT&Vertical
Gender	Female

FHD127SSFxx-H000101

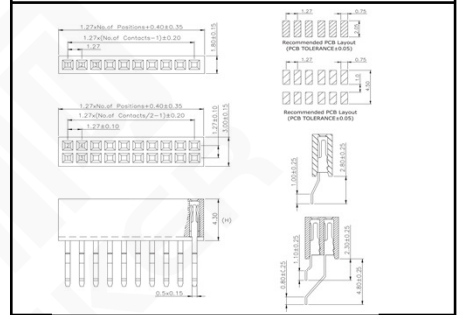
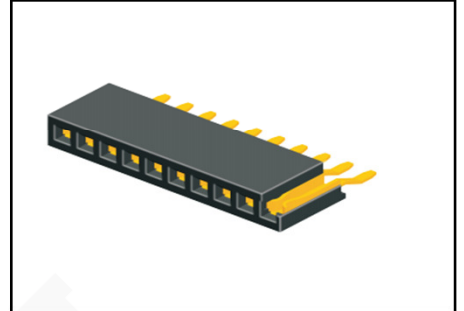

Technical Data	
Current Rating:	1A
Pitch	1.27mm
H Size	4.3mm
Solder type&Structure	SMT&Vertical
Gender	Female

FHD127SDFxx-H000101

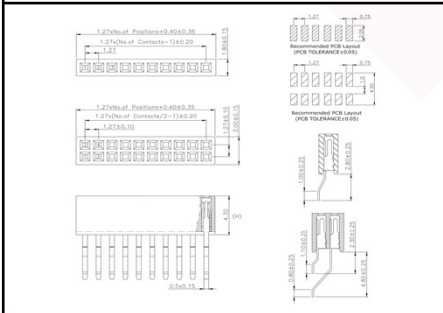
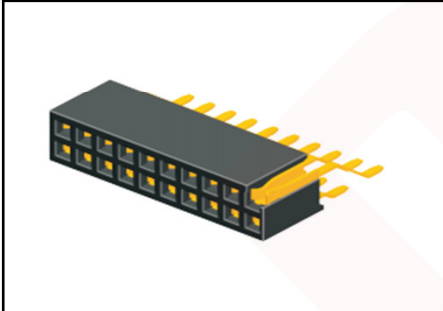

Technical Data	
Current Rating:	1A
Pitch	1.27mm
H Size	4.3mm
Solder type&Structure	SMT&Horizontal
Gender	Female

FHD127DFxx-V000101

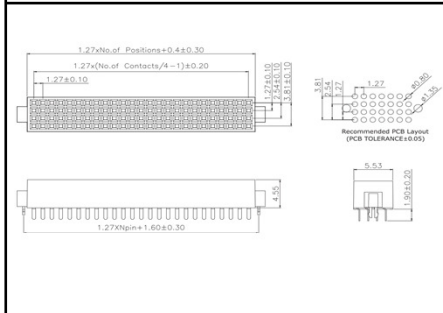
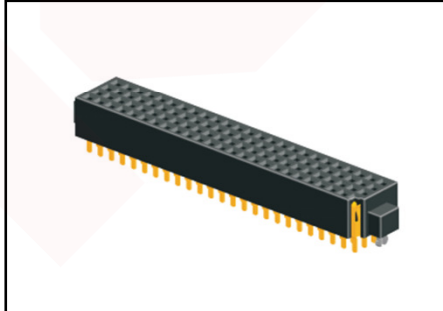

Technical Data	
Current Rating:	1A
Pitch	1.27mm
H Size	4.5mm
Solder type&Structure	DIP&Vertical
Gender	Female

BHD127DFMxx-V000101

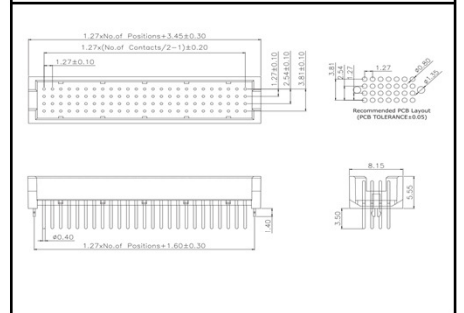

Technical Data	
Current Rating:	1A
Pitch	1.27mm
H Size	4.5mm
Solder type&Structure	DIP&Vertical
Gender	Male

FHD254DSFxx-V000101

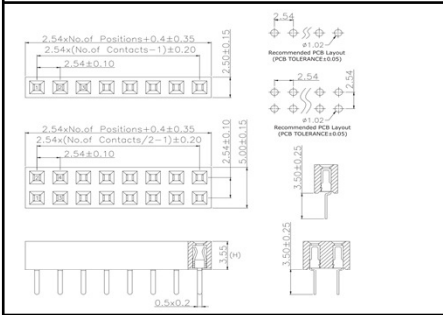
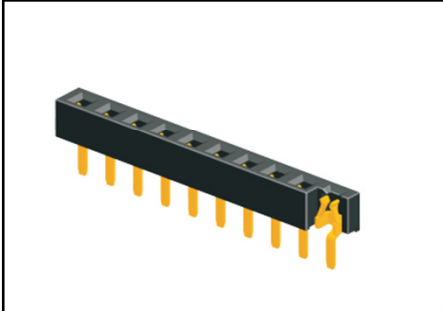

Technical Data

Current Rating:	3A
Pitch	2.54mm
H Size	3.55mm
Solder type&Structure	DIP&Vertical
Gender	Female

FHD254DDFxx-V000101

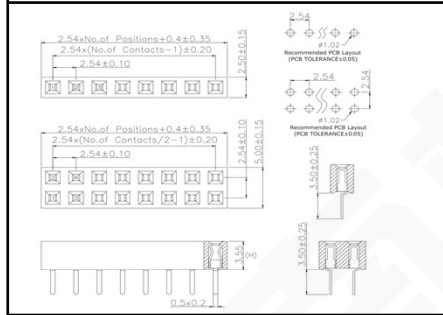
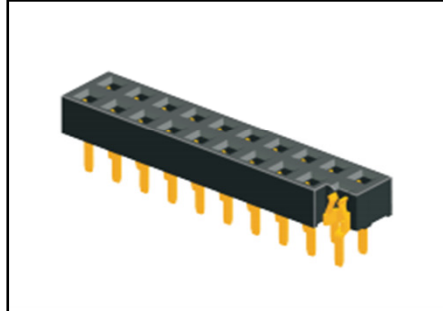

Technical Data

Current Rating:	3A
Pitch	2.54mm
H Size	3.55mm
Solder type&Structure	DIP&Vertical
Gender	Female

FHD254DSFxx-V000101

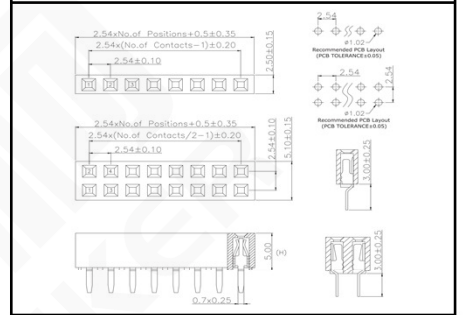
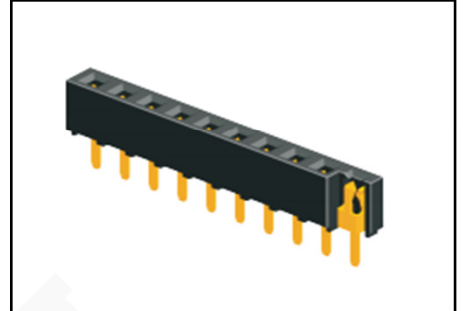

Technical Data

Current Rating:	3A
Pitch	2.54mm
H Size	5.0mm
Solder type&Structure	DIP&Vertical
Gender	Female

FHD254DDFxx-V000101

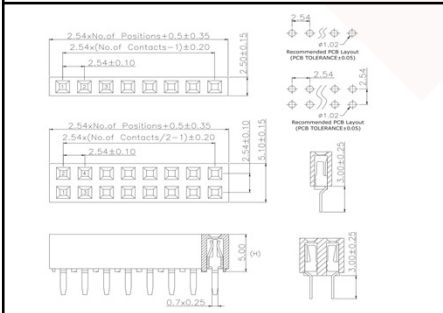
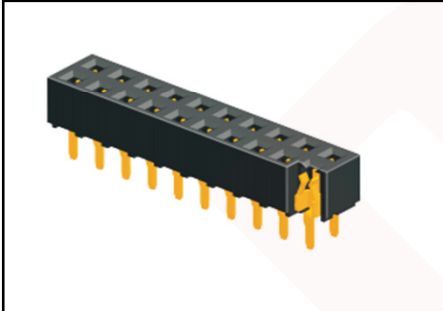

Technical Data

Current Rating:	3A
Pitch	2.54mm
H Size	5.0mm
Solder type&Structure	DIP&Vertical
Gender	Female

FHD254DSFxx-H000101

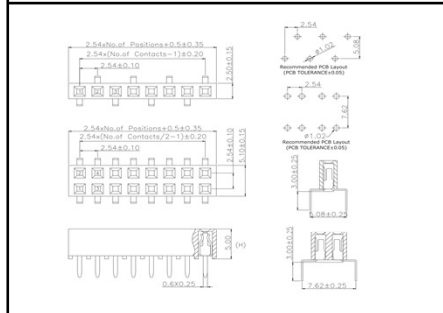
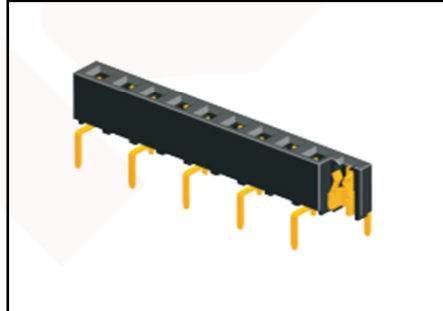

Technical Data

Current Rating:	3A
Pitch	2.54mm
H Size	5.0mm
Solder type&Structure	DIP&Vertical
Gender	Female

FHD254DDFxx-H000101

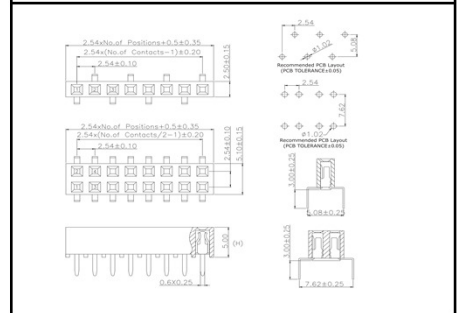
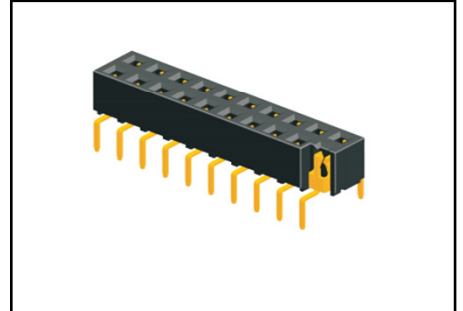

Technical Data

Current Rating:	3A
Pitch	2.54mm
H Size	5.0mm
Solder type&Structure	DIP&Vertical
Gender	Female

BTB050SD0xxx-V0001x1

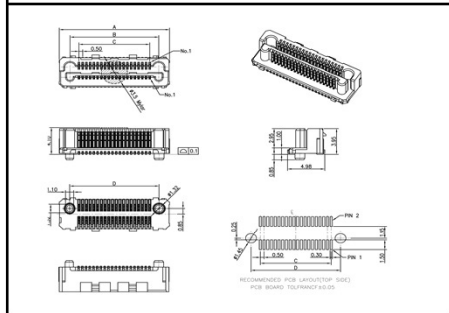
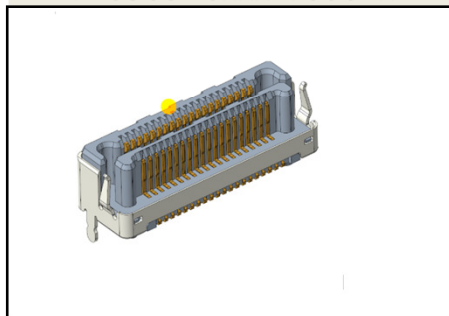

Technical Data

Current Rating:	0.5A
Pitch	0.5mm
Pin	10-150pins
Solder type&Structure	SMT&Vertical
Gender	Neutral

BTB080SDMxxx-V00x101

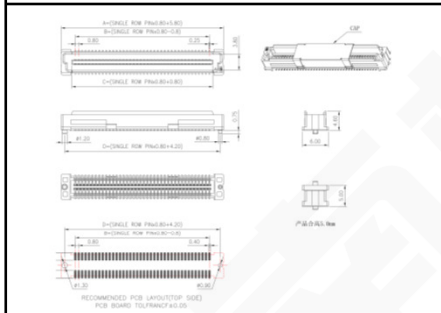
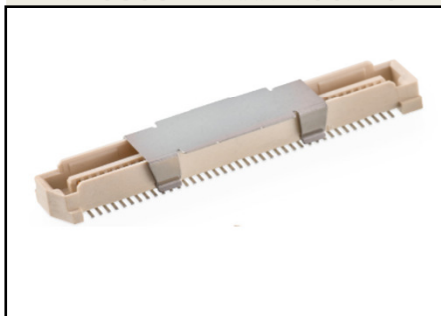

Technical Data

Current Rating:	1.5A
Pitch	0.8mm
Pin	10-200pins
Solder type&Structure	SMT&Vertical
Gender	Male

BTB080SDFxxx-V00x101

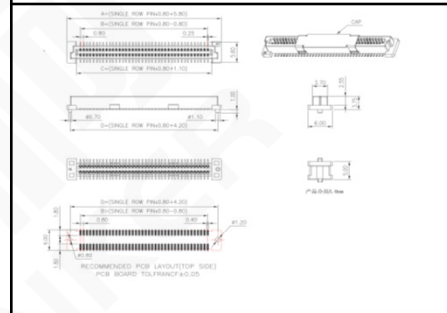
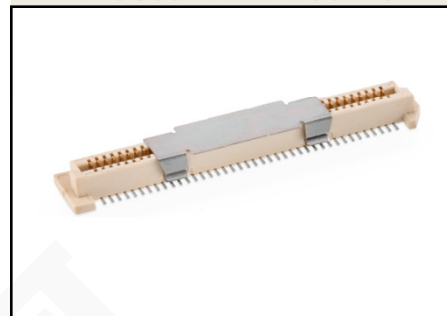

Technical Data

Current Rating:	1.5A
Pitch	0.8mm
Pin	10-200pins
Solder type&Structure	SMT&Vertical
Gender	Female